



# 1200 Watt Windmill

 **Bluetooth**

**48V**



## User's Manual

Ver.2018.08.16

# Table of Content

- 1. SAFETY .....1**
- 1.1 Mechanical Hazard .....2
- 1.2 Electrical Hazard .....2
  
- 2. SYSTEM SPECIFICATION .....4**
- 2.1 Specification .....4
- 2.2 Performance .....4
- 2.3 Wiring Requirement .....5
  
- 3. SYSTEM PROTECTION .....7**
- 3.1 Digital-controlled MPPT .....7
- 3.2 Mechanical Stop Switch .....10
  
- 4. PACKAGE CONTENTS .....12**
- 5. INSTALLATION PROCEDURE .....13**
- 6. MAINTENANCE .....19**
- 7. FAQs .....20**
- 8. WARRANTY .....25**
  
- APPENDIX A IMPORTANT SAFETY INSTRUCTIONS .....28**
- APPENDIX B BEAUFORT WIND SCALE .....30**
- APPENDIX C MPPT CHARGE CONTROLLER .....31**
- APPENDIX D REGISTRATION FORM .....41**

# 1. SAFETY

Your wind turbine is designed with your personal safety as the first priority. However, there are still some inherent dangers involved with any electrical and/or mechanical equipment. Safety must be the primary concern as you plan the location, installation and operation of the turbine. Please read the following:

## **Important Safety Instructions**

Please take the time to read through this manual prior to assembly.

- (1) Place this instruction manual in a safe place for reference.
- (2) Wait until a calm day to install or perform maintenance on your wind turbine with activation of mechanical stop switch.
- (3) Listen to your wind turbine should you hear any mechanical noise, maintenance may be required, please contact The Products Customer Service.
- (4) After installation re-adjust and tighten the screws and bolts.
- (5) Adhere to proper grounding techniques as established by the National Electrical Code (NEC).
- (6) Your wind turbine must be installed in accordance with this manual and local and national building code. Incorrect installation may void your warranty.
- (7) Wind turbine blades spin at a potentially dangerous speed this must be respected. Never approach a turbine in motion.
- (8) Note wire size (gauge chart included) prior to wiring. Any under sizing of wire can be potentially dangerous.

## **1.1 Mechanical Hazard**

Rotating blades present the most serious mechanical hazard. The rotor blades are made of very strong thermoplastic. At the tip, the blades may be moving at velocities over 15 m/s. At this speed, the tip of a blade is nearly invisible and can cause serious injury. Under no circumstances should you install the turbine where a person could come in contact with moving rotor blades.

## **1.2 Electrical Hazard**

The wind turbine is equipped with sophisticated electronics designed to provide protection from electrical dangers. Please note that the inherent personal dangers from electrical current still exist, therefore caution should always be used when connecting this and other electrical devices. Heat in a wiring system is often a result of too much current flowing through an undersized wire or through a bad connection. Please consult wire guide table below.

Batteries can deliver a dangerous amount of current. If a short circuit occurs in the wiring from the batteries, a fire can result. In order to avoid this threat, a properly sized fuse or circuit breaker is required in the lines connecting to the battery.

## **Choosing your wind turbine's location**

Prior to the mounting of your wind turbine, you must carefully consider a location. Things to consider when thinking about your location

- A) Distance from any obstacles that will cause turbulence, trees,
  - Locate your Turbine in windy sites so as not to disturb neighbors and animals around. The noise and vibration element cannot be got rid of even if this wind turbine offers the lowest noise than any others on the market. The better location of your Turbine requires

avoiding personnel or animal activities within a 33 ft (10 m) radius, and human habitation and wildlife within a 66 ft (20 m) radius.

- The minimum recommended tower height is 22 ft (7 m) to 33 ft (10 m). The wind speed below 22 ft (7 m) constrained by the terrain is low and chaotic.

For example: If wind in your area is more than 30 mph (13.4 m/s), the height of 22 ft (7 m) is recommended. The higher the Turbine stands (more than 10 m), the much stress your pole kit will sustain. Also, the Turbine possibly brakes in extreme weather conditions.

- The rooftop may not be the best place for your Turbine. Here are three reasons.
  - a. The flow is more turbulent above the rooftop and leads to the low wind power availability.
  - b. The stress the pole kit sustains varies in rooftop constructions. The evaluation and stability cannot be guaranteed.
  - c. The slight noise and vibration still affect sleep for some sensitive people and animals. The rooftop may not be the best place for your Turbine. Here are three reasons.

B) Distance from MPPT controller and battery bank

C) Any local zoning restrictions

D) Clearance of power lines

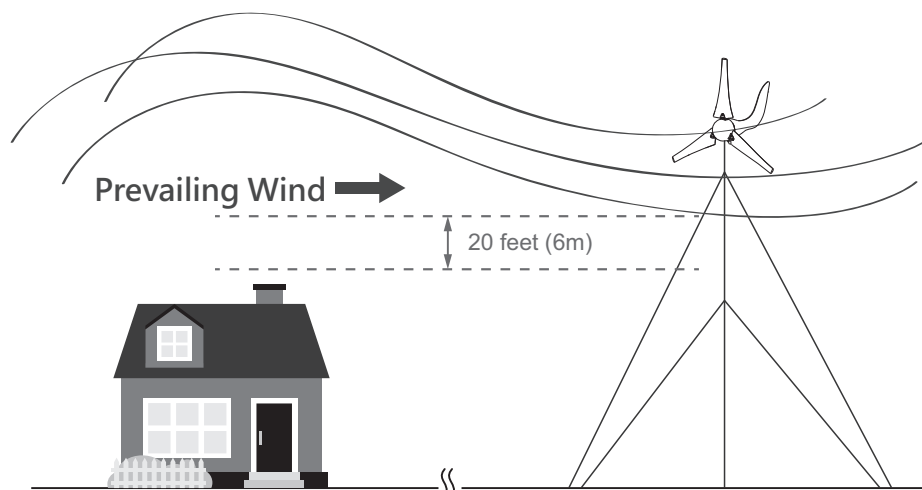

## 2. SYSTEM SPECIFICATION

### 2.1 Specification

Wind Turbine	Model	1200 Watts Wind Turbine
	Rated speed	31.3 mph / 14 m/s
	Rated power	1200 watts
	Voltage with MPPT	48 volts
	Start-up wind speed	>2.24 mph / >1 m/s
	Cut-in wind speed	5.59 mph / 2.5 m/s
	Survival wind speed	112 mph / 50 m/s
	Rotor diameter	5.6 ft / 1.7 m
	Number of blades	3
	Blade material	glass fiber + PP
	Suggested battery capacity	>200 A / HR

- \* The mechanical stop switch should be turned on when the wind speed upwards 35 mph (16 m/s).
- \* Survival wind speed means that the wind turbine will survive at 112mph (50 m/s) when the mechanical stop switch is turned on. Exceeding this will result in wind turbine failure and collapse.

### 2.2 Performance

The following power curve shows the performance you should expect from your wind turbine. During smooth, steady wind speed, you can expect to see output resembling the curve illustrated below. To convert between power and current use the following formula:

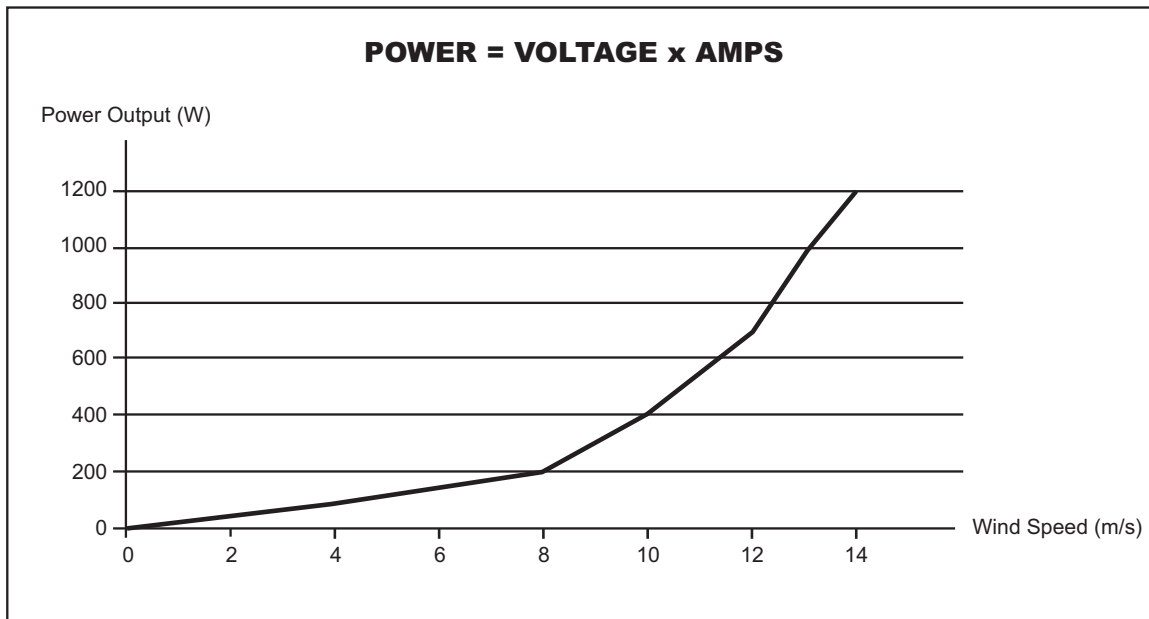

### 2.3 Wiring Requirements

24 Volt System, AWG / Metric Wire Size mm<sup>2</sup>

Distance between Turbine and MPPT	0-30 ft. (0-9 m)	30-60 ft. (9-18 m)	60-90ft (18-27 m)	90-150 ft. (27-46 m)	150-190 ft. (46-58 m)
Wire Gauge	14/2.5 mm <sup>2</sup>	12/4 mm <sup>2</sup>	10/6 mm <sup>2</sup>	8/10 mm <sup>2</sup>	6/16 mm <sup>2</sup>

**Caution 1:** Any under sizing of wire can be potentially dangerous; our warranty doesn't cover damages caused by using incorrect wire gauge. The distance from the MPPT to your turbine should not exceed 60 meter for safety reasons (Be sure to include the height of tower).

**Caution 2:** Please review the above wire gauge table to install the correct wires. We recommend these as the minimum wire sizes for the distance from the MPPT to your turbine for optimal performance. Always use the largest gauge wires that are practical and affordable. Local, state, and / or national electrical codes take precedence over these general recommendations.

## System wiring diagrams



### NOTE:

Please refer to the recommended wire gauge table and use the correct wire size for your system.



### NOTE:

Please apply the Mechanical Stop Switch simultaneously. Refer to the SEC. 3.2 for detailed info.

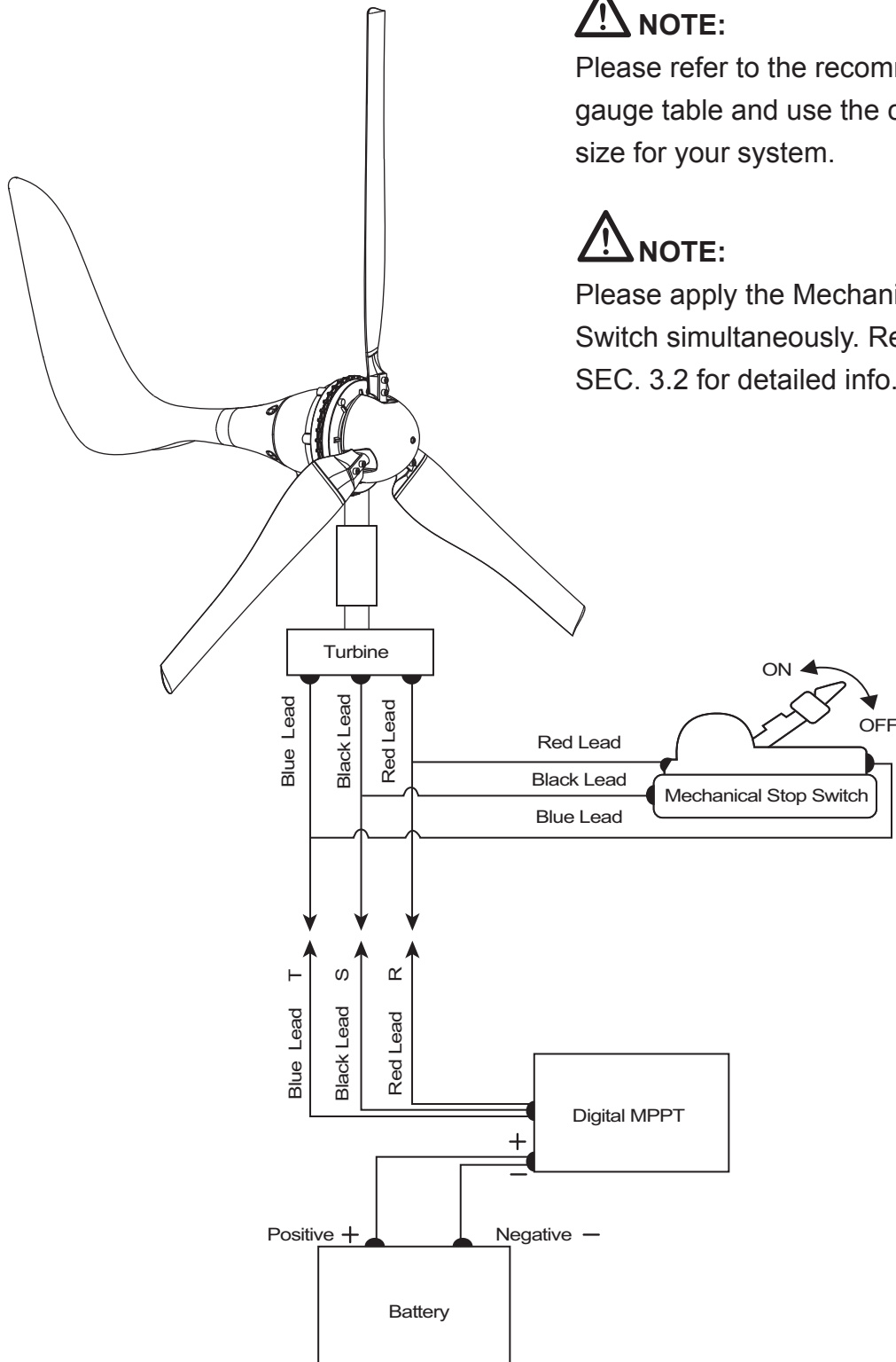



# 3. SYSTEM PROTECTION

## 3.1 Digital-controlled MPPT

- MCU fully digital-controlled MPPT wind power charger
- Boost & Buck conversion, large DC input voltage range
- Smart load management function, braking function

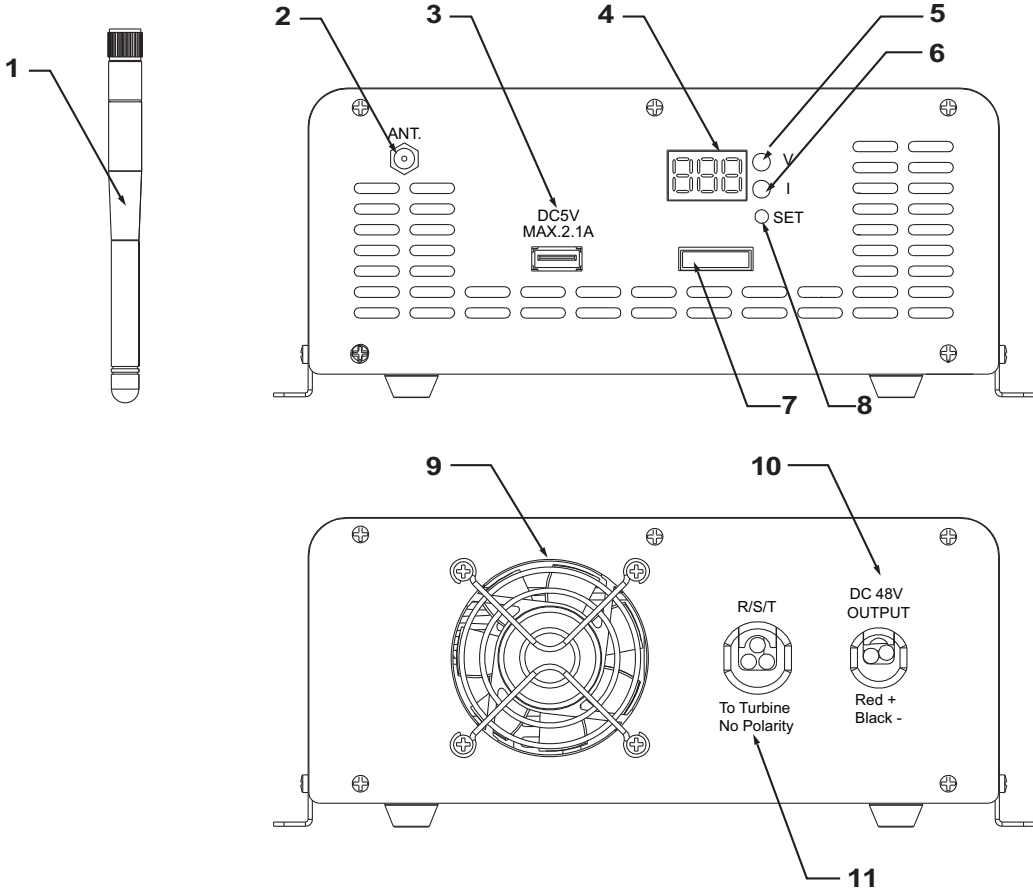

- (1) not inc. Antenna
- (2) Extra Antenna port
- (3) USB Port
- (4) LCD Display
- (5) LED Indicator (green light: voltage)
- (6) LED Indicator (green light: current)
- (7) Data Port
- (8) SET Button
- (9) Cooling Fan
- (10) DC Output Cable
- (11) RST Cable

## Specification

Rated Output Power	1200W Max.
Battery Voltage Range	40 ~ 66VDC
Charger Efficiency	95% Max.
Battery Protection Voltage	56V ± 6VDC
Rated Load Current	40A (Max.45A)
Over-Speed Braking	≥1400 RPM

## LED indication

PR1	Over RPM Protection
PR2	High Battery Voltage Protection
PR3	Over Charging Current Protection
PR4	MPPT Overheat Protection
PR5	Low Battery Warning
PR6	Turbine Overheat Protection
PR7	Wind Gust Protection

***When the auto protections above occur, the braking will last 3 minutes before Turbines start again.***

1. Under normal situations, the green V LED should be lit once connected to a battery.
2. When the SET button is pressed, the green V and I LED's will be lit alternately, the voltage, current and total accumulated wattage (kWh) measurements will be shown on the LED screen.

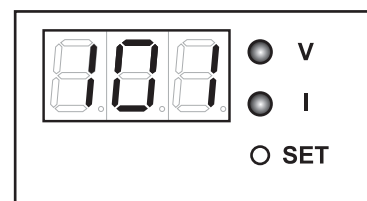
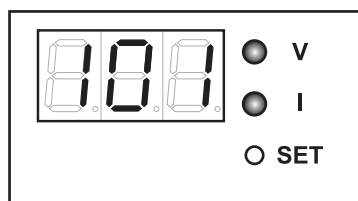
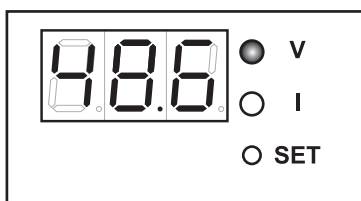

3. If the green V and I LED's flash at the same time, it means that your system is in its protection (brake) mode. To evaluate the problem, further press the SET button, and the LED display will show a set code PR1~PR7. Refer to the description listed above to know what each code stands for.

**System protection:** Your MPPT charge controller, equipped with sensors inside the unit, comes with four main protection functions.

**Self-protection:** The MPPT charge controller has a temperature sensor. Temperature of the internal circuitry is moderated by an internal fan that is activated at 45°C (110°F). When the temperature exceeds 65°C (150°F), the MPPT will apply both the fan and braking system to prevent damage.

**Protection for Battery:** The MPPT charge controller can sense the voltage of battery and the current output/input to battery. If the parameter of voltage and current is wrong, then the braking system will be turned on.

**Protection for Wind Turbine:** The MPPT charge controller can sense the rotation speed of wind turbine. If the rotation speed is over the setting value in program, the braking system will be turned on. The latest version of MPPT charger controller is also equipped the phase detector technology. If the AC output wave from generator is incorrect, that means the generator may be damaged. At that moment, the MPPT will apply the braking system and the LED lamp to warn users.

**Protection for No Battery Connection:** When the MPPT charge controller shuts down due to the abnormal battery and improper connection; it will cause free-spin issues. At 150 RPM and above, the MPPT charge controller should apply the braking system automatically and the power from the wind turbine should be cut off at once. The wind turbine will turn on and brake repeatedly. Under safety condition, please check the battery wire and function as soon as possible.

### 3.2 Mechanical Stop Switch

The MPPT controller has an integrated battery controlled braking mechanism. Further to this protection we have incorporated a secondary level of safety and convenience with a mechanical 3-phase AC brake. During periods of high winds (upwards of 35 mph / 16 m/s) it is strongly advised to utilize both MPPT brake and mechanical stop switch. The use of mechanical stop switch will not affect the voltage of your battery.

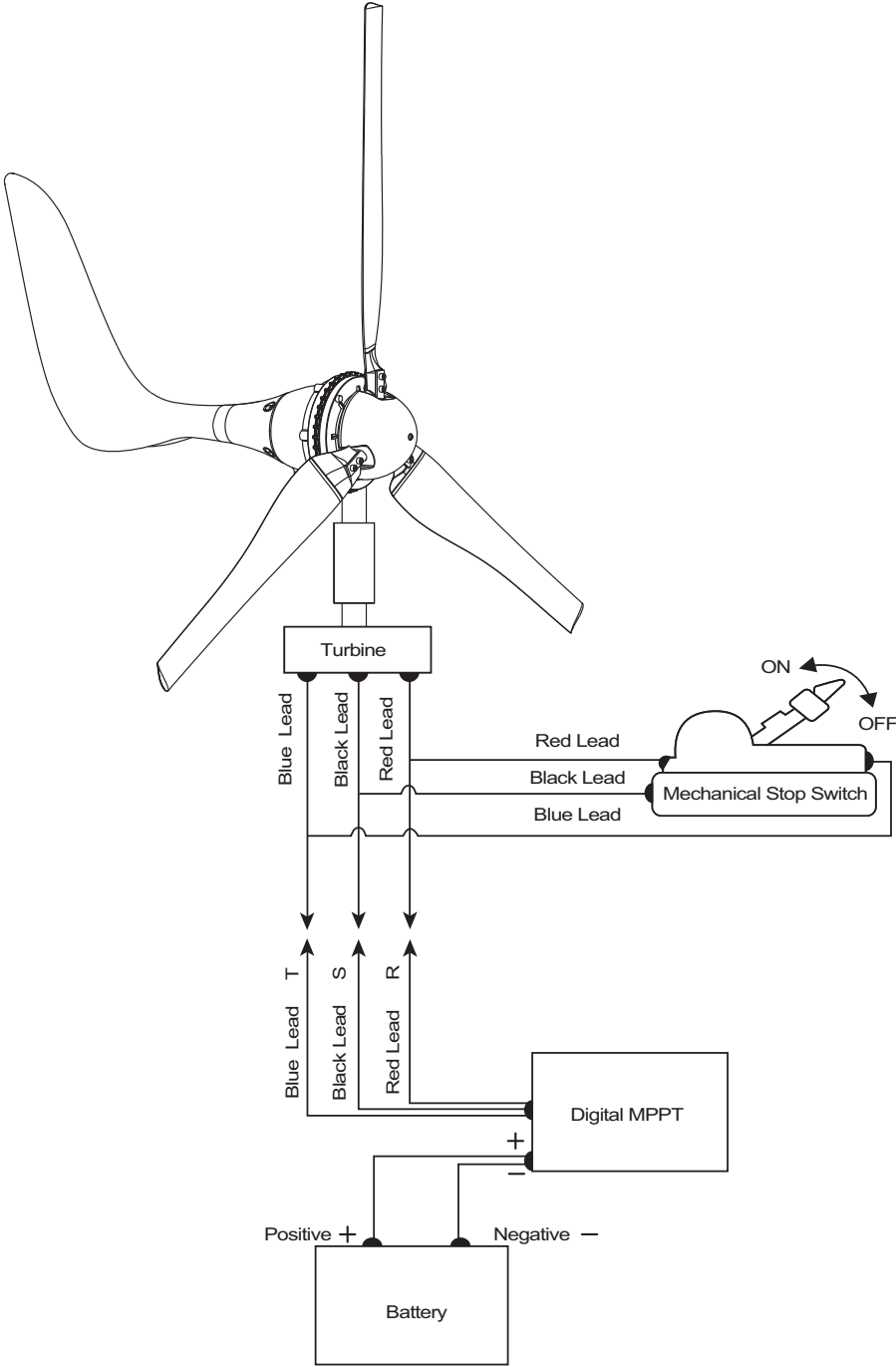

We strongly advise the activation of the mechanical stop switch during any maintenance of or around your Turbine. This will prevent the blades spinning and voltage to be transferred. Likewise during initial installation please activate the mechanical brake. The final step in installation of Turbine, controller, and battery should be release of this mechanical stop switch.

The mechanical stop switch is pre-wired for your convenience with 10 AWG wire and battery terminal connections. Place the corresponding wires (Red, Black, Blue) from the mechanical stop switch into the MPPT input terminals. They should match the same colored wires from your Turbine. Your Turbine and stop switch share input terminals on the MPPT, this provides a parallel connection.

Test the connection of your mechanical stop switch at the point of initial installation. Push the brake "ON". You should see the Turbine stop its rotation. Continue to apply this brake during the remainder of your installation. Should the Turbine continue to spin, check your terminal connections. **Do not approach the Turbine without activation of this mechanical stop switch under any circumstance !**

- It is strongly advised to test both mechanical stop switch and MPPT periodically.
- The mechanical stop switch is pre-wired with 10 AWG wire, this should not be altered.
- The mechanical stop switch should be placed close to your MPPT in a dry ventilated environment.
- For multiple turbine applications please use one mechanical stop switch for each wind turbine.
- This mechanical stop switch has been designed specifically for your wind turbine; it should not be incorporated into other models.

## 4. PACKAGE CONTENTS

Check the parts listed with the contents of the box and make sure that you have everything needed for assembly.

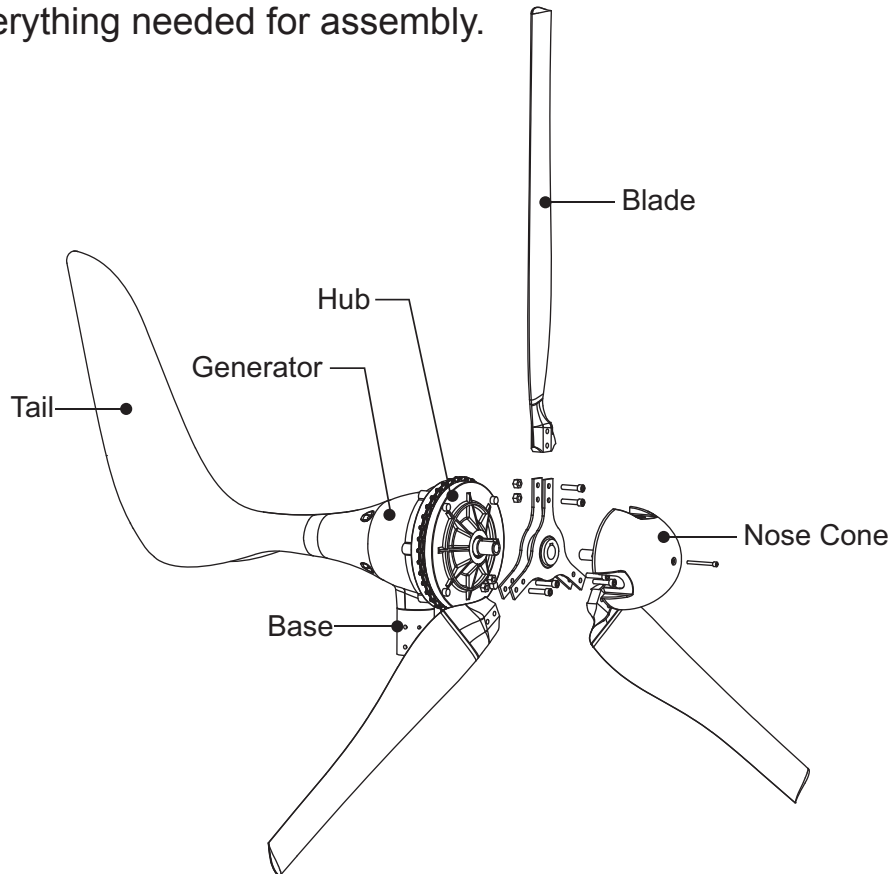

*Caution: The edges of the blades are sharp. Please handle with care.*

### Part List

Generator	1	Hex Screw (M5XL50)	1
Blade	3	Hex Screw (M8XL40)	6
MPPT Charger Controller	1	Hex Screw (M5XL20)	4
Hub	1	Set Screw (M8XL12)	4
Tail	1	Spacer for Tail	4
Nose Cone	1	Washer (M16)	1
Mechanical Stop Switch	1	Nut (M8)	6
Double Head Round Key	1	Hex Key (3mm)	1
Ring	1	Hex Key (4mm)	1
Sleeve (M16)	1	Hex Key (6mm)	1
Washer (M8)	12		

# 5. INSTALLATION PROCEDURE

**Step 1:** Open the boxes to ensure all parts are present.



**Step 2:** Fasten the blades on hub with 6 x hex screws (M8XL40), 6 x nuts (M8) and 12 x washer (M8) by using hex key 6mm.





***Caution: Make sure that all of the bolts are secured and the dots all face to the operator.***



**Step 3:** Put the cables through the pole. Install the Turbine to your chosen tower securely and fasten the bolts by using the hex key 4mm.



The outside diameter of the iron pipe should be 48.3 mm, the thickness of iron pipe should be 1.9 mm at least.

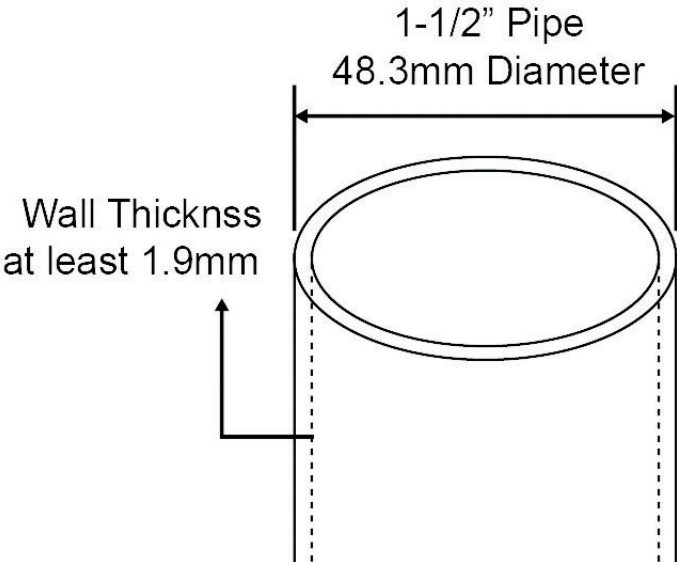

**Step 4:** Install the hub. Put the ring on the shaft. Insert the double head round key to the hole of the shaft. Put the hub onto it and fasten the sleeve (M16) by using wrench.

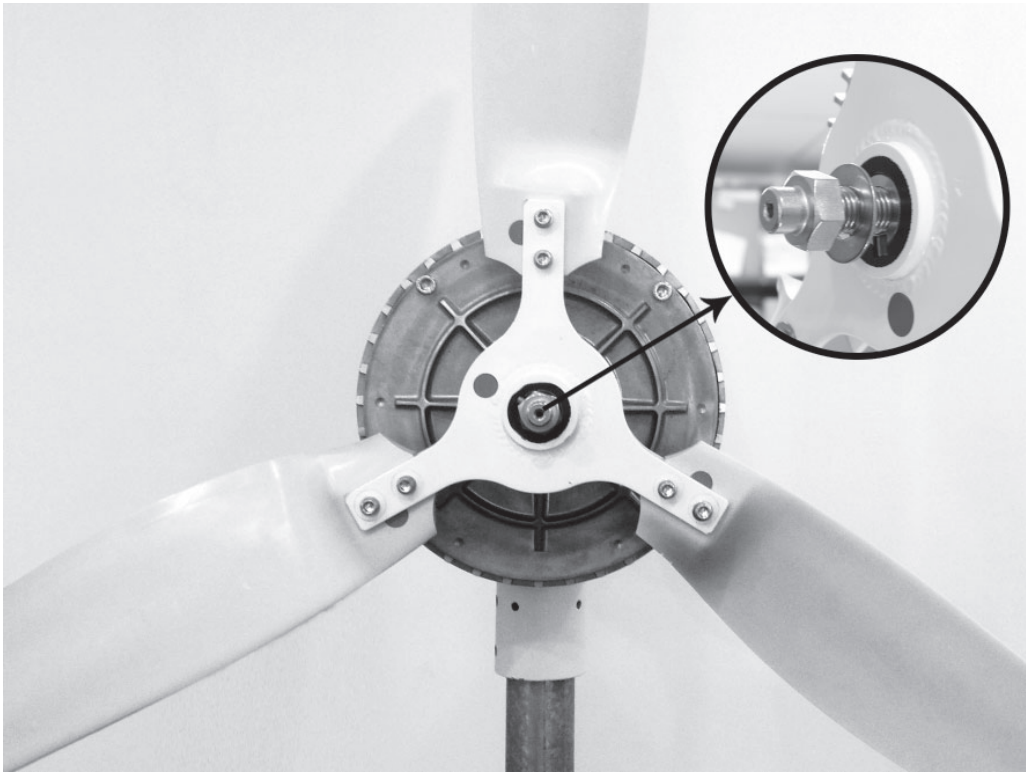
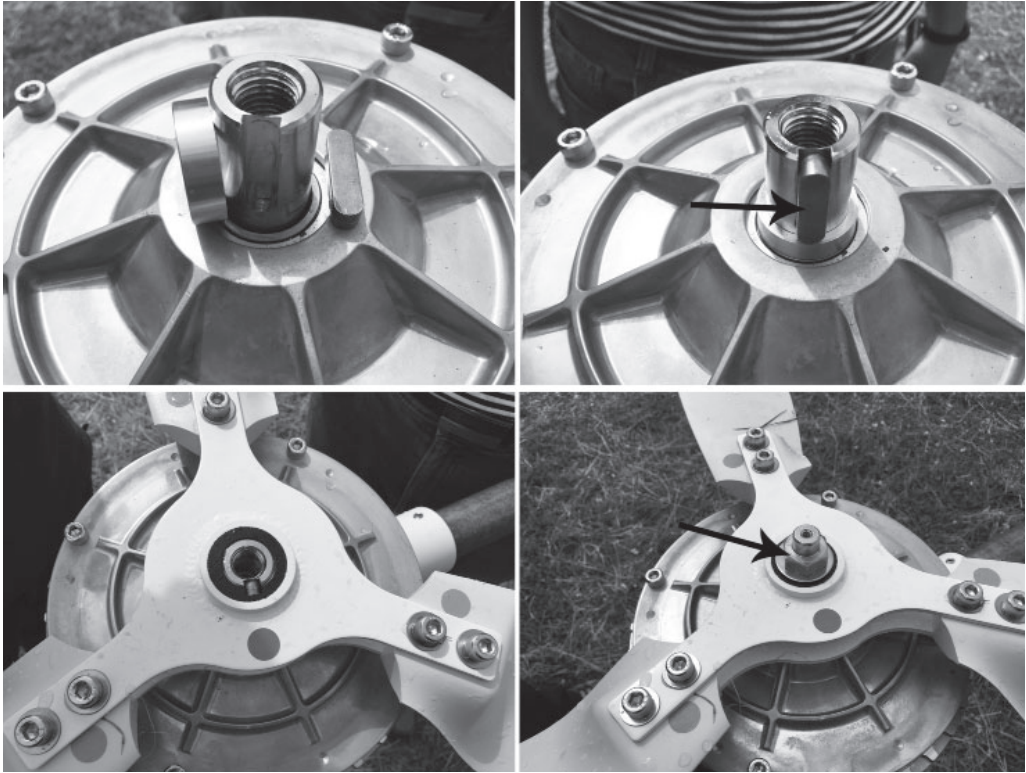

**Step 5:** Tail Fin assembly. Connect the tail fin to the Turbine with 4 x hex screw (M5XL20), 4 x set screw (M8XL12) and 4 x spacers by using hex key 3mm.

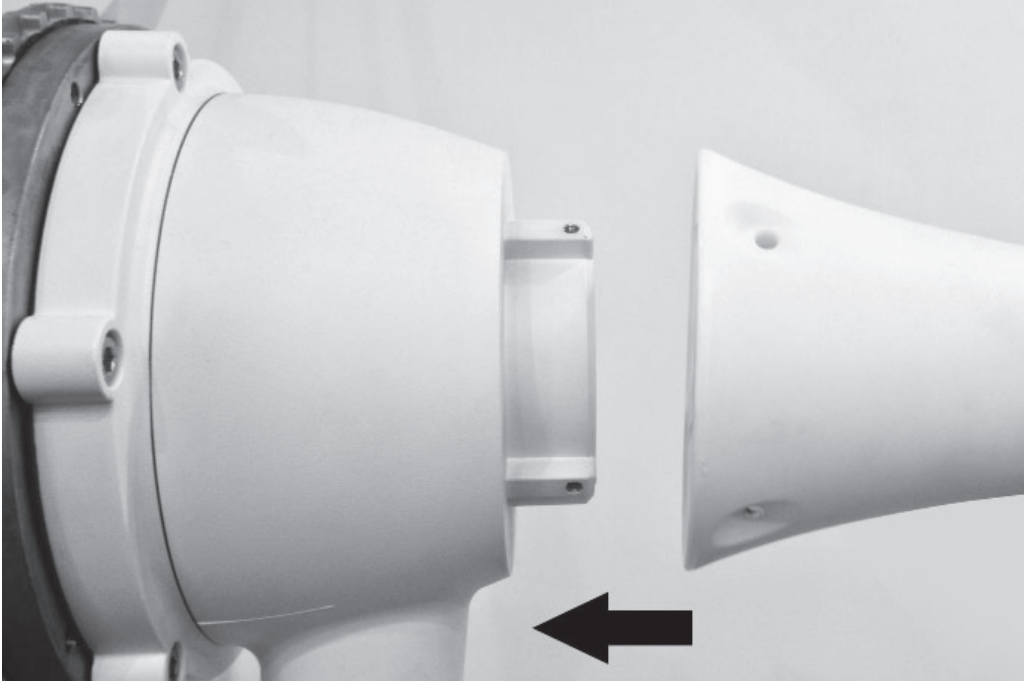

**Step 6:** Put the nose cone to the hub. Apply pressure to the connections to ensure a secure fit. Fasten the nose cone with hex screw (M5XL50) by using hex key 3mm.



**Step 7:** Final product diagram



## 6. MAINTENANCE

Your wind turbine has been designed to run for long periods without requiring any maintenance. Performance will be enhanced if you periodically inspect your system.

Review the following simple maintenance procedures and implement every six months.

**Caution: Do not go near the wind turbine during operation.**

**Caution: The blades are sharp. Please handle with care.**

- Check blades for superficial damage. Replace blades if damaged. It is important to not use blades that are damaged, as you will lose overall balance, resulting in a decrease in efficiency. Should you notice damage to the blades you must replace all 3. The blades are balanced as sets.
- Check the blade bolts and the hub nut for tightness.
- Check nosecone for cracks and tighten nuts.
- Wipe any excess dirt build-up from the blades.
- Check all electrical connections to make sure they are tight and free from corrosion.
- Check the voltage of your battery bank with a Multi-meter and clean the terminals.
- We suggest replacing the blades every five years for optimal performance.

## 7. FAQs

(1) How does the wind turbine control power and RPM in high winds?

Your wind turbine's operation will be halted to reduce the risk of damage due to overcharge and over spin of the rotor blades. This process of braking is handled internally through your MPPT charge controller.

(2) What is the maximum wind speed the wind turbine will survive, and do I need to take it down in a storm?

Your wind turbine is designed to operate in most climatic conditions. Should you expect or experience winds of 30 mph (13 m/s) upwards, please utilize your mechanical stop switch to protect from any over spin. When the wind is getting stronger up to 112 mph (50 m/s) it is necessary to lay down the Tower to offer further protection.

(3) How long will the bearings or other wearing parts last?

According to engineer calculations, the bearings should have a 10-year life span in 6 m/s average wind speed sites. Bearing life will vary from one application to another; however, you should expect at least a 5-year performance in adverse conditions and 10-year in normal conditions.

(4) Can the wind turbine be connected in reverse-polarity to the battery without causing any damage?

Reverse polarity will cause damage to both your MPPT controller and battery if not quickly remedied. Always double check any wiring to reduce the risk of reverse polarity. Your turbine is equipped with polarity protection to reduce the risk of damage, but it is still possible to degrade your wiring and cause damage to the overall system.

(5) Will it hurt my wind turbine to short-circuit the output?

No, the wind turbine is designed to be short-circuited as a normal shutdown procedure by a fuse. The function of the stop switch is to both disconnect the turbine from the batteries as well as short-circuit the output of the turbine.

(6) Where can I locate tubing to make a tower?

Your wind turbine is designed to make mounting as simple and straightforward as possible. Should you not wish to purchase the custom tower kit feel free to utilize schedule 48.3 mm steel tubing. This should be available through your local hardware outlet.

(7) What is the difference between copper and aluminum wire?

Generally aluminum wire is less conductive, so it must be bigger for the same amp load and resistive losses as copper. The wind turbine uses copper or tinned copper for the yaw wires.

(8) What battery should I choose for my wind turbine?

There are multiple battery options in today's market– flooded lead acid, absorbed Glass mat (AGM), gel cell and NiCad. There is no definitive choice for your alternative energy needs. Normally the choice of battery is determined by availability and pricing. Should you have questions regarding batteries please consult a local battery supplier. Or view: [www.batterycouncil.org](http://www.batterycouncil.org). The capacity of your battery bank is determined by your use. Below is a good guideline.

- **24-volt systems – 200 Amp-hours**

- **Possible Battery Configurations (suggested)**

**12 VOLT BATTERIES  
IN SERIES TO MAKE  
A 24 VOLT SYSTEM**

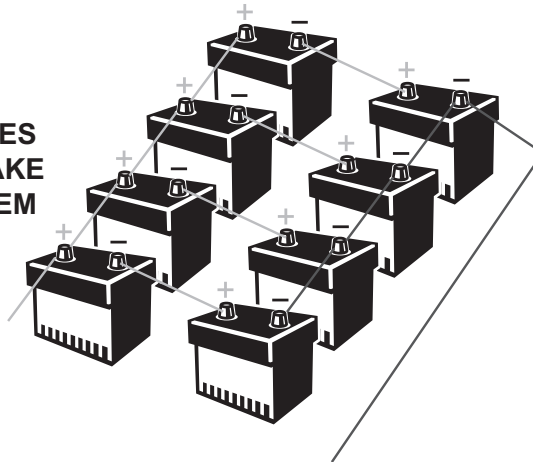

(9) Is lightning protection necessary?

You should ground your wind turbine. Proper grounding (illustrated below) provides protection to individuals and equipment by eliminating the possibility of dangerous voltage. Remember a steel tower is a conduit for lightning. Every wind turbine and turbine tower needs to be grounded at the tower base even though the system may be grounded at the battery bank. Grounding the tower at its base may help prevent shocks to persons touching the tower due to lightning or electrical faults. Please take the time to review the National Electrical Code (NEC) and local building and zoning regulations for complete requirements. Even in “Off Grid Systems” there are multiple ways for tower grounding, the most common method is a copper clad steel electrode(s) driven into the soil. Please view the following grounding diagram.

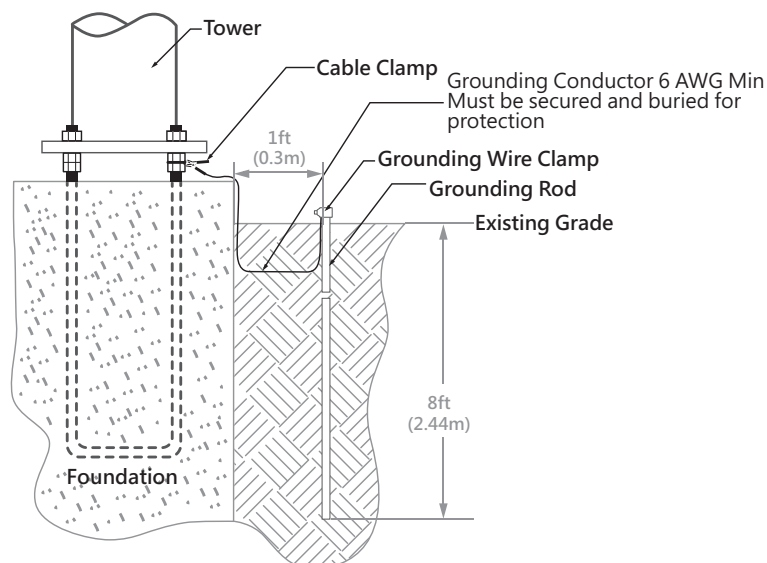



(10) What effect does radio interference have on my wind turbine?

The internal circuitry of the wind turbine is shielded and filtered to prevent radio interference, and has been tested to insure electro-magnetic compatibility.

(11) What effect does my wind turbine have on radio transmissions?

The wind turbine normally does not affect radio transmitters. Care should be taken, however, to route power lines from the wind turbine away from the power and antenna lines of a radio transmitter. An old ham radio operator's trick is to twist positive and negative wires together to provide an even distribution of EMF noise across both wires, which serves to cancel out the electrical noise created.

This technique can be used on the wind turbine power lines, on the radio's power lines, and on transmission wires. Transmission lines should always be kept as far from power lines as is practically possible. Proper grounding of the wind turbine and other system components must also be observed.

(12) Will it affect the regulation of my wind turbine to install an RF (radio frequency) filter?

An RF filter should not affect the regulation of the wind turbine, but any electronic devices placed in line with the turbine must be rated for the proper current and voltage. It is best to place any line filters on the power lines for the load device that requires it, and as close to the device as possible.

## **TROUBLESHOOTING**

You may require an extra person to assist with these tests.

(1) Remove the blade/hub from the turbine. Replace the rotor hub nut on the rotor shaft.

(2) Quickly spin the rotor shaft manually with your fingers while connecting and disconnecting the red and black wires (turbine must not be connected to batteries).

(3) With the red and black wires connected to each other, the shaft should be more difficult to turn. When the wires are disconnected it should spin freely. Should this not be true please contact supplier or manufacturer.

(4) With your wind turbine connected to your battery bank, use an electric hand drill to spin the rotor shaft.

(5) Below 500 RPM, the rotor should spin freely without friction.

(6) At 500 RPM and above, the wind turbine should be charging the battery. You should feel resistance on the rotor shaft if the shaft is not rotating; contact your turbine dealer or manufacturer. Be aware your battery banks needs to be under 12V or 24V for this testing as the turbine needs to read a charge.

## **8. WARRANTY**

We warrant your product to be free from defects in material and/or workmanship for a period of 1 year from original date of purchase. Warranty coverage is extended only to customer (original purchaser).

If product proves defective during warranty period, manufacturer, at its option will:

1. Replace wind turbine with new or refurbished product.
2. Correct reported problem

Customers warranty continues to be valid on repaired or replaced product from original warranty date.

### **Restrictions**

This warranty covers defects in manufacturing discovered while using the product as recommended by the manufacturer. The warranty does not apply to: (a) equipment, materials, or supplies not manufactured by manufacturer. (b) Product that has been modified or altered other than by manufacturer or without prior manufacturer's approval. (c) Has been exposed to winds exceeding 50 m/s. (d) Windstorms (upwards of Beaufort Wind Scale 7) lightning and Hail damage. (e) Repairs performed by other than authorized support staff. (f) All acts of God; misuse, negligence or accidents. (g) Tower foundation and wire has not been installed, operated, repaired or maintained in accordance with the instructions supplied by manufacturer. Any service identified in the above list or product is found not to have any defect in manufacturers' workmanship or materials the customer will be responsible for the costs of all repairs and expenses incurred by manufacturer.

## **Disclaimer**

EXCEPT FOR THE EXPRESSED WARRANTY SET FORTH ABOVE, THE MANUFACTURER DISCLAIMS ALL OTHER EXPRESSED AND IMPLIED WARRANTIES, INCLUDING THE IMPLIED WARRANTIES OR FITNESS FOR A PARTICULAR PURPOSE, MERCHANTABILITY AND NON-INFRINGEMENT. NO OTHER WARRANTY, EXPRESSED OR IMPLIED, WHETHER OR NOT SIMILAR IN NATURE TO ANY OTHER WARRANTY PROVIDED HEREIN, SHALL EXIST WITH RESPECT TO THE PRODUCT SOLD UNDER THE PROVISIONS OF THESE TERMS AND CONDITIONS. THE MANUFACTURER EXPRESSLY DISCLAIMS ALL LIABILITY FOR BODILY INJURIES OR DEATH THAT MAY OCCUR, DIRECTLY OR INDIRECTLY, BY USE OF THE PRODUCT BY ANY PERSON. ALL OTHER WARRANTIES ARE EXPRESSLY WAIVED BY THE CUSTOMER.

## **Warranty Claims & Return Policies**

To be eligible for service under this warranty, customer must either contact manufacturer either through written request or by telephone to submit a service request for the wind turbine covered by this warranty within specified period (1 year from original date of purchase) and request a return authorization (RA) number, This RA # must be issued before any product can be returned.

All notifications must include the following information:

- a) Description of alleged defect
- b) How the wind turbine was being used
- c) Serial #
- d) The original purchase date
- e) Name, phone #, address of party requesting warranty

Within 2 to 3 business days we will provide the customer with an RA# and will direct customer to location where the product is to be returned. Once an RA has been issued the customer has 30 days to return the product. Failure to deliver the product within the 30 days results in the RA as no longer being valid and a new RA must be issued. Manufacturer is under no obligation to accept any product that is returned to them without a proper RA #.

### **LIMITATION OF LIABILITY**

UNDER NO CIRCUMSTANCES WILL THE MANUFACTURER OR ITS AFFILIATES OR SUPPLIERS BE LIABLE OR RESPONSIBLE FOR ANY LOSS OF USE, INTERRUPTION OF BUSINESS, LOST PROFITS, LOST DATA, OR INDIRECT, SPECIAL, INCIDENTAL, OR CONSEQUENTIAL DAMAGES OF ANY KIND REGARDLESS OF THE FORM OF ACTION, WHETHER IN CONTRACT, TORT (INCLUDING NEGLIGENCE), STRICT LIABILITY OR OTHERWISE, RESULTING FROM THE DEFECT, REPAIR, REPLACEMENT, SHIPMENT OR OTHERWISE, EVEN IF THE MANUFACTURER OR ITS AFFILIATE OR SUPPLIER HAS BEEN ADVISED OF THE POSSIBILITY OF SUCH DAMAGE.

## APPENDIX A IMPORTANT SAFETY INSTRUCTIONS

Read these instructions below before installing your wind turbine to ensure people and property against accidents. Please also make sure it is set up under environmental and operating conditions.

1. Locate your wind turbine in windy sites so as not to disturb neighbors and animals around. The noise and vibration element cannot be got rid of even if wind turbine offers the lowest noise than any others on the market. The better location of your wind turbine requires avoiding personnel or animal activities within a 33 ft (10 m) radius, and human habitation and wildlife within a 66 ft (20 m) radius.
2. The height of installation should be 22 ft (7 m) to 33 ft (10 m). The wind speed below 22 ft (7 m) constrained by the terrain is low and chaotic. For example: If winds in your area are more than 30 mph (13 m/s), the height of 7 m is recommended. The higher the wind turbine stands (more than 10 m), the much stress your pole kit will sustain. Also, the wind turbine possibly brakes in extreme weather conditions.

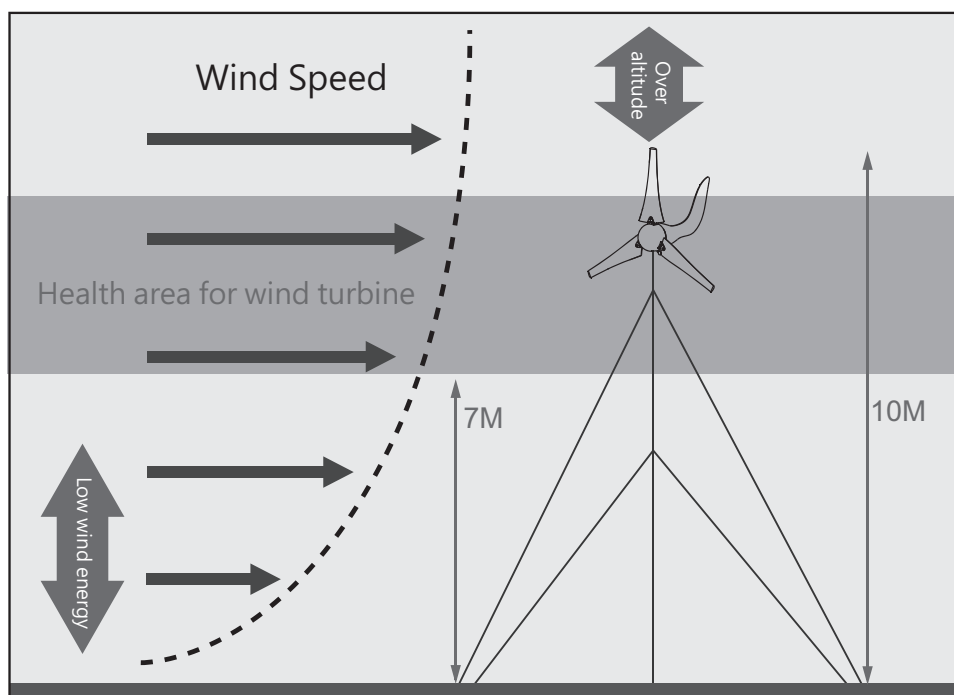













## **Operating Environment:**

- A. Operating Temperature: -4°F (-20°C) ~ 122°F (50°C)
- B. Operating Humidity: < 80%
- C. Average Wind Speed: < 34MPH (<15 m/s or <54KMH)
- D. Max. Peak Wind Speed: < 45MPH (<20m/s or <70KMH)
- E. Elevation: < 1000m
- F. Applicable Installation Height: 8.85ft~33ft (2.7m~10m)

*It is subject to IEC 61400-2 safety standards. If the operating temperature and wind speed exceed the above-mentioned limits, turn on the manual brake in proper way to shut off the Turbine.*

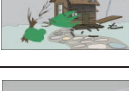
3. The rooftop may not be the best place for your wind turbine. Here are three reasons.
  - a. The flow is more turbulent above the rooftop and leads to the low wind power availability.
  - b. The stress the pole kit sustains varies in rooftop constructions. The evaluation and stability cannot be guaranteed.
  - c. The slight noise and vibration still affect sleep for some sensitive people and animals.
4. Check the three wires from the wind turbine output periodically. Please check AC current from your MPPT. If the outputs are not consistent, please contact the distributor for further instruction. For safety reasons, please stop operating your wind turbine.
5. Check the battery health periodically. The abnormal battery and improper connection will cause over-spin issues. The wind turbine's operation should be halted to reduce the risk of damage due to over spin of the rotor blades.
6. Check the battery health periodically. The abnormal battery and improper connection will cause over-spin issues. The Wind Turbine's operation should be halted to reduce the risk of damage due to over spin of the rotor blades.
7. Survival wind speed means that the wind turbine will survive 112 mph (50 m/s) when the manual brake is turned on. Exceeding this stated wind speed will result in wind turbine failure and collapse.

## APPENDIX B BEAUFORT WIND SCALE

Beaufort No.	Description	Avg. Wind Speed (knot/h)	Avg. Wind Speed (km/h)	Avg. Wind Speed (m/s)	Avg. Wind Speed (mi/h)	image
0	Calm	<1	<2	<0.55	< 1.24	
1	Light air	1 – 3	2 - 6	0.55~1.66	1.24~3.73	
2	Light breeze	4 – 6	7 – 12	1.95~3.33	4.35~7.46	
3	Gentle breeze	7 – 10	13 – 19	3.61~5.27	8.08~11.81	
4	Moderate breeze	11 – 16	20 – 30	5.55-8.33	12.43~18.64	
5	Fresh breeze	17 – 21	31 – 40	8.61-11.11	19.26~24.85	
6	Strong breeze	22 – 27	41 – 51	11.38~14.16	25.48~31.69	
7	Moderate gale	28 – 33	52 – 62	14.45~17.22	32.31~38.53	
8	Fresh gale	34 – 40	63 – 75	17.5~20.83	39.15~46.60	
9	Strong gale	41 – 47	76 – 87	21.11~24.16	47.22~54.06	
10	Storm	48 – 55	88 – 103	24.44~28.61	54.68~64.00	
11	Violent storm	56 – 63	104 – 117	28.88~32.5	64.62~72.70	
12	Hurricane	≥ 64	≥ 118	>32.77	> 73.32	

\* It is strongly advised to manually turn on your Mechanical Stop Switch during periods of high winds (upwards of Beaufort Wind Scale 7). Please refer to Sec. 3.2 for detailed information



## **APPENDIX C MPPT CHARGE CONTROLLER**

### **1200W Digital MPPT Charge Controller**

A MPPT, or maximum power point tracker is an electronic AC to DC converter that optimizes the match between the turbine and the battery bank, DC motor, or DC pump. (These are usually called power trackers or MPPT's for short. The power output of a wind turbine varies almost directly with the amount wind - but the voltage and current do not. The current drops off much faster than the voltage. Under low wind conditions the panel or turbine may be putting out higher volts, but the amperage will be lower than the units rating.

### **What does a Maximum Power Point Tracker (MPPT) do?**

A MPPT controller looks at the output of your wind generator, and compares it against the battery voltage. It then uses an algorithm to calculate the absolute best power that the wind turbine can put out. The MPPT controller then converts its findings to the best possible voltage in order to allow for maximum AMPS running in to the battery bank. Most MPPT controllers are at 92-97% efficient however the controller is 97-99% efficient in the conversion. Here is where the optimization or maximum power point tracking comes in.

## **Overview**

The Maximum Power Point Tracking (MPPT) charge controller enables the wind turbine to achieve its highest possible performance by periodically tracking the Maximum Power Point of the turbine. The MPPT can be used with battery systems from 24V or 48V DC. The MPPT set points are fully adjustable to allow use with virtually any battery type, chemistry, and charging profile. This user guide will demonstrate the basic operation and troubleshooting of your MPPT charge controller.

## Wiring

The three output wires from wind turbine are Blue / Red / Black and transform three phase AC current. The three wires need to be connected to the “RST” terminal located on the back of the digital MPPT charge controller. (Three phase power is a method of electric power transmission using three wires) .

The mechanical stop switch is pre-wired for your convenience with 10 AWG wire and battery terminal connections. Place the corresponding wires (red, black, blue) from the mechanical stop switch into the MPPT input terminals. This should match the similar colored wires from your turbine. Your turbine and stop switch share input terminals on the MPPT. This provides a parallel connection. (see figure below).

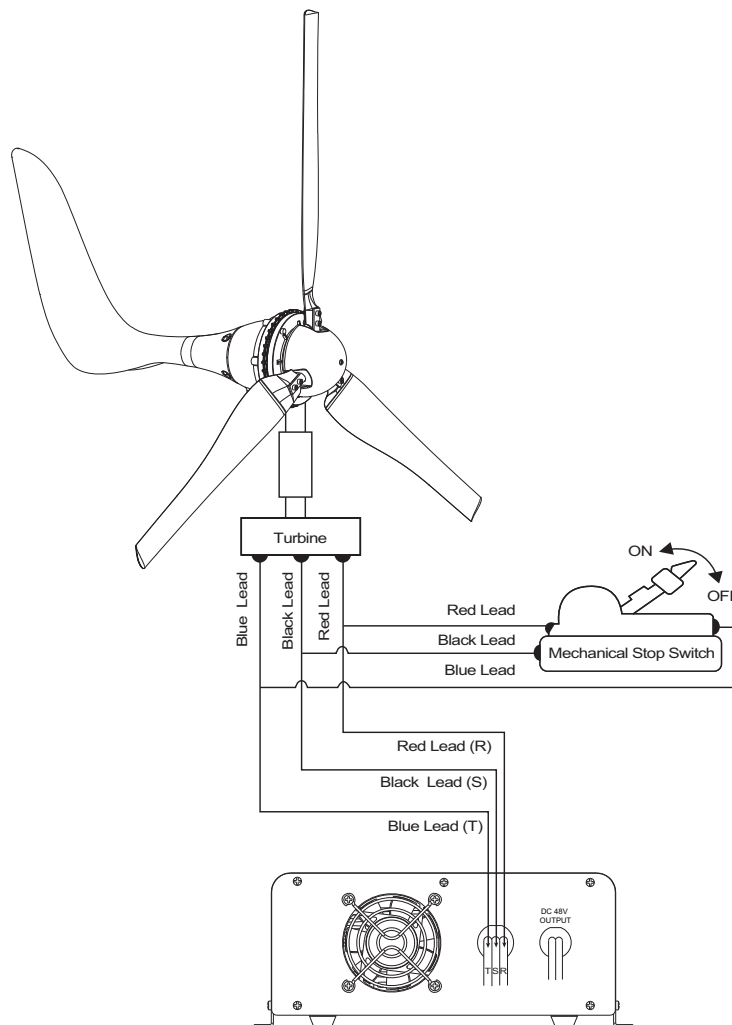

## Function

- (1) not inc. Antenna
- (2) Extrac Antenna port
- (3) USB Port
- (4) LCD Display
- (5) LED Indicator (green light: voltage)
- (6) LED Indicator (green light: current)
- (7) Data Port
- (8) SET Button
- (9) Cooing Fan
- (10) DC Output Cable
- (11) RST Cable

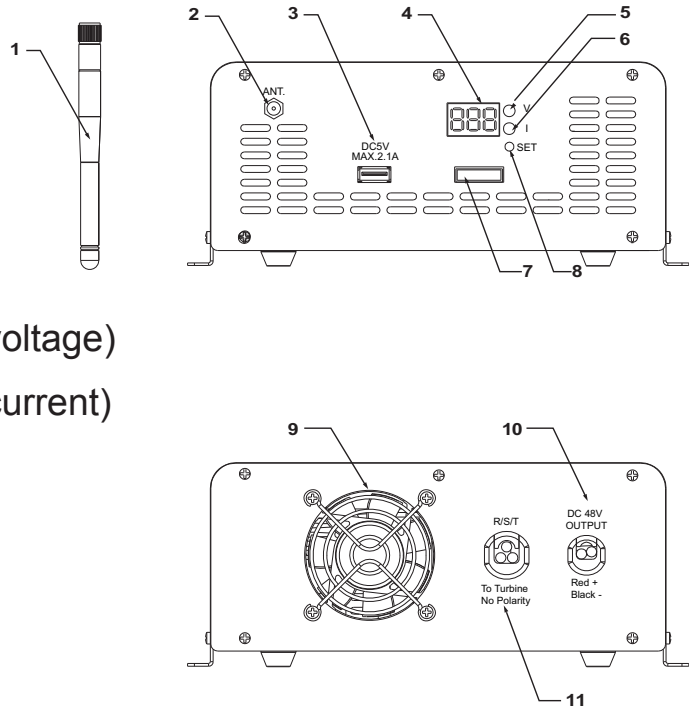

MPPT LED INDICATION		High Battery Voltage Protection		MPPT Overheat Protection		Turbine Overheat Protection	
	High RPM Protection		Over Charging Current Protection		Low Battery Warning		Wind Gust Protection

- [ PR1 ] High RPM Protection
- [ PR2 ] High Battery Voltage Protection
- [ PR3 ] Over Charging Current Protection
- [ PR4 ] MPPT Overheat Protection
- [ PR5 ] Low Battery Warning
- [ PR6 ] Turbine Overheat Protection
- [ PR7 ] Wind Gust Protection

1. Under normal situations, the green “ V ” LED should be lit once connected to a battery.
2. When the “ SET “ button is pressed, the green “ V “ and “ I “ LED’s will be lit alternately, the voltage, current and total accumulated wattage (KWH) measurements will be shown on the LED screen.

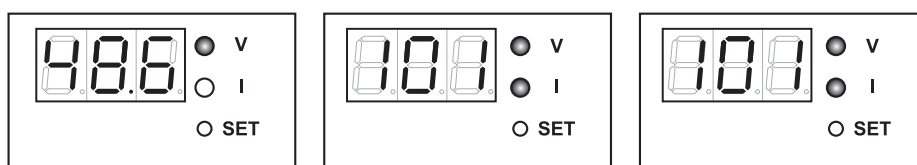

### **Suggested Battery Charger Set points:**

The battery manufacturer should provide you with specific instructions on the following maintenance and charging regulation set point limits for the specific batteries. The following information can be used when the manufacturer's information is not available. Note: Higher settings can be used with non-sealed batteries, but water consumption will be greater and excessive temperatures when charging may occur.

#### **Sealed Lead Acid – AGM / GEL 12V 24V 48V**

ABSORB voltage set point 14.3V 28.6V 57.2V

FLOAT voltage set point 13.6V 27.2V 54.4V

#### **Non-Sealed Lead Acid 24V 24V 48V**

ABSORB voltage set point 14.8V 29.6V 59.2V

FLOAT voltage set point 13.6V 27.2V 54.4V

### **Multi –Stage Battery Charging**

The MPPT charge controller is a sophisticated multi-stage battery charger that uses several regulation stages to allow fast recharging of the battery system while ensuring a long battery life. This process can be used with both sealed and non-sealed batteries. The MPPT will automatically set the charging regulation voltage set points (absorb & float) for the selected nominal battery voltage, however, always follow the battery manufacturer's recommended charging regulation voltages. The MPPT charging regulation stages correspond to the chart below.

## **Bulk**

This stage provides the maximum power to the battery -- voltage increases while charging.

A bulk charge is automatically initiated when the battery voltage is below the absorb and float voltage set points. The bulk charge will continue until the absorb voltage set point is achieved.

## **Absorbing**

This stage limits the amount of power going to the battery -- the voltage is held constant. The absorb charge will continue for the duration of the bulk cycle or until the 2 hours (default) absorb time limit is reached. Example, if a bulk charge takes 1 hour to reach the absorb voltage set point then the absorb charge will continue for 1 hour as well. However, if a bulk charge takes 3 hours to reach the absorb voltage set point then the absorb charge will last for 2 hours only. A bulk charge will be re-initiated if the battery voltage is not sustained at the absorb voltage set point.

## **Float**

This stage reduces the charging voltage to prevent overcharging of the batteries. A float charge follows after the absorb charge is completed. The MPPT will not re-initiate another bulk charge if the float voltage set point is not sustained, however, it will continue to charge the battery until the float voltage set point is achieved. Note: A bulk charge can be initiated if the battery voltage falls below the float voltage set point if the re-bulk (ReBV) voltage option is set.

## **Understanding the various modes**

The modes of operation will change occasionally during the day based on turbines output and battery system state of charge. The MPPT operating modes are displayed through the LED's.

## **Sleeping**

Happens when the wind turbine's voltage is less than the battery voltage or charger current is below the minimum cutoff (Low cutoff) current. This may also appear briefly during the day when the MPPT is transitioning between certain states, and because of other conditions.

## **Absorb**

There is an external DC source (wind generator/hydro) keeping the battery at or above the absorb set point.

## **Wakeup**

As the turbine's open circuit voltage ( $V_{oc}$ ) rises above the battery bank's voltage by approximately 2 volts, the MPPT controller gets ready to work to deliver the best possible power to the batteries. During this period, the MPPT is calculating the PWM (Pulse-width modulation) duty cycles by turning on power supply voltages in the proper sequences, and making internal calibrations. At wakeup, the MPPT closes its relays and will then start sweeping the input voltage, (the "initial" sweep), towards the battery voltage. This may happen numerous times at both dawn and dusk until there is enough power from the turbine to keep charging the battery bank. Wakeup is also a time when the MPPT controller acquires a new  $V_{oc}$ .

## **Sweeping**

In Auto-Sweep MPPT mode, the MPPT is either doing an initial sweep of the turbines voltage from  $V_{oc}$  towards battery voltage after wakeup, or is doing a periodic dithering mini-sweep to stay on the max power point. Below 5 amps of battery output current, this will flash briefly as the MPPT operates at the Park MPP voltage. This signal may also appear briefly if the MPPT has reached the max battery current setting and is raising the

turbines operating voltage to keep the battery current from exceeding the maximum battery output current limit setting.

### **Absorb**

There is an external DC source (wind generator/hydro) keeping the battery at or above the absorb set point.

### **Bat Full**

The MPPT is waiting for the battery voltage to fall to just below the float voltage set point before continuing with the float stage. This may also be displayed when external DC charging sources are present.

### **Re-Cal**

There is certain abnormal conditions that can confuse the current measuring method in the MPPT. When and if this happens, the MPPT will temporarily stop and re-calibrate. This may sometimes happen because of negative current, i.e., current coming out of the input terminals instead of into the input terminals turbine breaker. A new voc is also acquired during a Re-Cal.



## **TROUBLESHOOTING**

### **MPPT does not boot / power-up**

1. Check battery connection and polarity. Reverse polarity or improper connection will cause power-up issues.
2. Check if the battery voltage is greater than 6V. A battery voltage less than 14V may not power up the MPPT.

### **MPPT is inactive**

1. Is battery voltage greater than the absorb voltage set point (compensated absorb voltage)?  
If yes, the MPPT will not wake up since the battery voltage is at/above the absorb target voltage set point.
2. Is the Turbines voltage greater than the battery voltage by at least 2 volts?  
The output voltage has to be at least 2 volts greater than the battery voltage for the initial wakeup.
3. Check the turbines breaker (or fuse) ensure that the turbines breaker (or fuse) is sized appropriately.

### **MPPT not producing expected power**

1. Are wind conditions optimal?  
Wind turbines in locations with constantly high wind speeds bring best return on investment. The primary consideration in a wind generator is the average wind speed at the installation site. A different turbine will give optimum performance at a site with average wind speeds below 15mph than one at a site with speeds in the low 20mph range.
2. Are the batteries charged? Is the MPPT in the absorbing or float stage?  
If so, the MPPT will produce enough power to regulate the voltage at the absorption or float set point voltage, therefore, requiring less power in these modes.

3. What is the short circuit current of the wind turbine? Use a multimeter to determine if a short circuit current is as expected. There might be a loose / faulty wire connection.
4. Is the turbine's voltage close to the battery voltage?  
If so, the panels could be warm/hot causing the Maximum Power Point of the array to be at or lower than the battery voltage.

### **MPPT sweeping frequently**

1. What is the current limit set point?  
When the current limit set point is achieved the MPPT will continue sweeping to maintain the targeted current limit.
2. What is the sweep interval set point?  
A short sweep interval time will cause the MPPT to sweep frequently.  
A sweep interval of 7 to 10 minutes is recommended.

### **MPPT Internal Fan**

Should the internal fan be running when the MPPT is producing power?  
The internal fan will only run when the internal temperature has reached ~ 65 degrees Celsius or 149 degrees Fahrenheit.

### **Warranty**

This product is covered under a one year limited warranty. Warrants to the original purchaser that this product is free from defects in materials and workmanship for the period of one year from date of purchase. Please note that proof of purchase including date, and expiration of complaint is required for warranty service.

Downloadable APP for Bluetooth Function



Or search on APP Store / Google Play

## APPENDIX D REGISTRATION FORM

	<b>Registration Form</b>
--	--------------------------

RA No.: \_\_\_\_\_

<b>Serial No.:</b>	<b>Date:</b>
<b>Event Date:</b>	<b>Location:</b>

Please fill out the following questions for further investigation.

1. The wire used between the wind turbine and the battery: \_\_\_\_\_

AWG or metric wire size \_\_\_\_\_ mm<sup>2</sup>

2. The interval between the wind turbine and the battery: \_\_\_\_\_ ft

or \_\_\_\_\_ m

3. The battery capacity: \_\_\_\_\_ A/Hr

**Photo (If applicable)**